

Global Sales Network



Vacancies for valuable distributors / agents in certain countries are available.

L&W MACHINE TOOLS, INC.

Factory: No. 53 Ho Tso St., Feng Yuan District, Taichung City, Taiwan
Export Office: 9F-8, No. 108, Sec.1, Zhong Qing Road, Taichung City, Taiwan
Tel: +886-4-2201-4701 Fax: +886-4-2203-6013
<http://www.lw-machinetools.com> E-mail: lwmachin@ms31.hinet.net



MATCHMAKER CNC



EFL SERIES FLAT BED CNC LATHE



EFL-560 SERIES

STURDY & HIGH CAPACITY

Conceived for the manufacture of large parts, the EFL-560 series is a flat bed CNC power lathe with integral structure of 4-slide way. The sturdy machine is made of stress-relieved cast iron of FC30, guaranteeing extraordinary metallic stability as well as accuracy consistency that is critically needed for heavy duty turning. The generous turning dimension of EF-560 series machine is widely applied in aerospace, naval architecture, oil, transportation and metal working industries.

Various spindle bore: Ø83, Ø105, Ø130 and Ø160 mm.

Max. turning length: 1000, 1500, 2000, 2500, and 3000 mm.

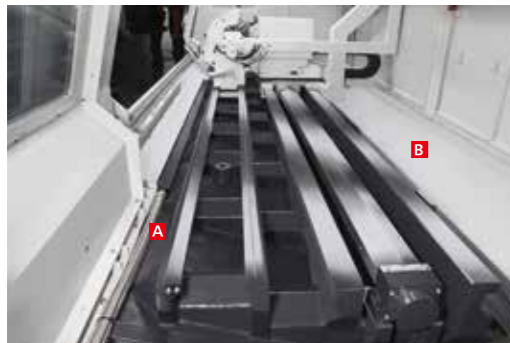

A SYMMETRIC

Z axis ball screw is centered in the 4-slide way machine bed; the symmetric design features the optimum kinetic performance and dynamic accuracy.

B The rear base surface is 30° slanted for efficient chip flush and collection.



SMOOTH MOTION

The oil quantity and the lubrication time interval of the centralized lubrication system is controlled via PLC; the service life time and the accuracy stability of X/Z axis square box guide ways is prolonged.



ERGONOMICS

The large turning dimension allows minimum structural interference; the easy-accessed spindle is ergonomically designed for easy workpiece loading/unloading.

EFL-510Y SERIES

FUNCTIONALTY & EFFICIENCY

For complicated and large components that need to be machined in one chucking operation, the MATCHMAKER EFL is the first choice. The 45° slant X axis saddle in combination with vertical Y axis and VDI40 live tooling C axis power up versatile machining performances such as turning, milling, drilling and tapping.

Various spindle bore: Ø83, Ø105, Ø130 and Ø160 mm.

Max. turning length: 1000, 1500, 2000, 2500, and 3000 mm.

Y axis travel: +/- 50 mm.



POWERHOUSE

The dynamic balanced transmission gearbox is firmly anchored on the machine base with 3-point-support design, delivering full power via premium grade spur gears and 3-step hydraulic gearing shifting mechanism, which is perfectly suitable for heavy duty operations.

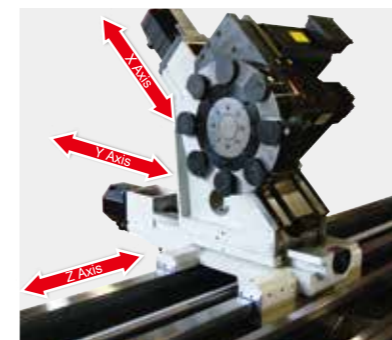

EFL-510Y axial indication

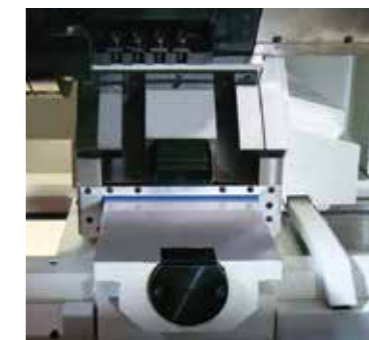

Square box way design of X/Y axes

OPTIONS



HYDRAULIC TURRET



VDI 40 LIVE TOOLING SYSTEM



HYDRAULIC TAILSTOCK



SPINDLE REAR SUPPORTING CHUCK



REAR CHIP FLUSHING SYSTEM



STEADY REST



CHIP CONVEYOR

GENERAL FEATURES



CONTROL SYSTEM

The EFL series machines are equipped with FAGOR 8055i Controller. The powerful arithmetic capability features stable performance as well as user-friendly man-machine interface (MMI). FANUC and SIEMENS controllers are available on request.



ELECTRICAL CABINET

Wires, cables and all pipes inside the electrical cabinet are well organized with clear wire numbers and labels. The easy-to-maintain cabinet is fitted with standard heat exchanger to stabilize the electrical components' performance, and to extend their service life time.



OIL COOLER

The EFL full series machines are standard with oil cooler to maintain spindle's constant operation temperature and the machine's high cutting accuracy.



2-STEP MANUAL TAILSTOCK

TECHNICAL DATA

POWER CHARTS OF SERVO MOTOR

— Torque (S6-40%) — Power (S6-40%)
 — Torque (Continues) — Power (Continues)

EFL 83/105mm bore with Fagor 15/22kw motor

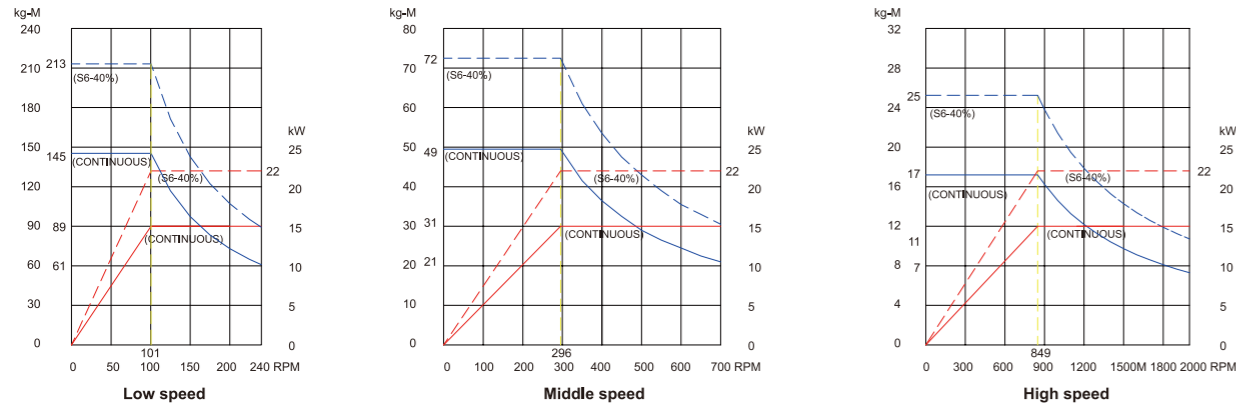

EFL 130mm bore with Fagor 15/22kw motor

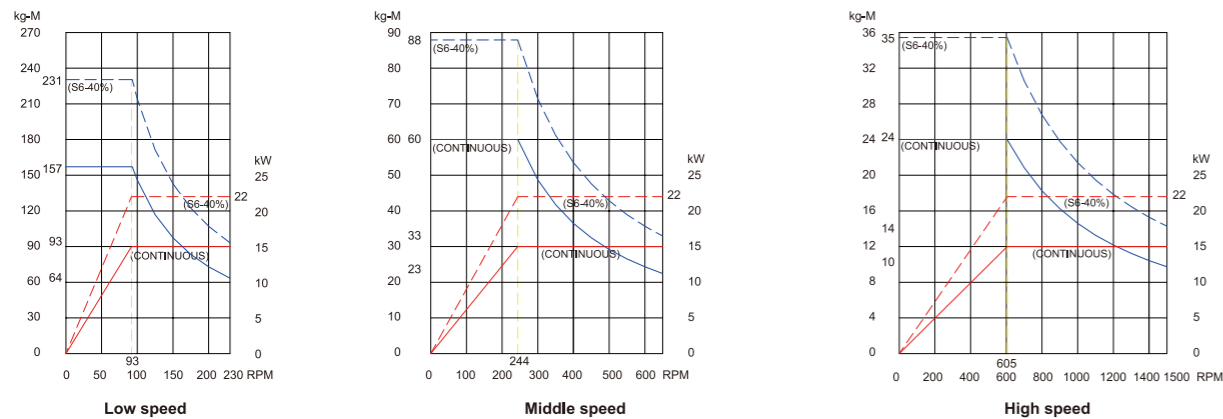

EFL 160mm bore with Fagor 15/22kw motor

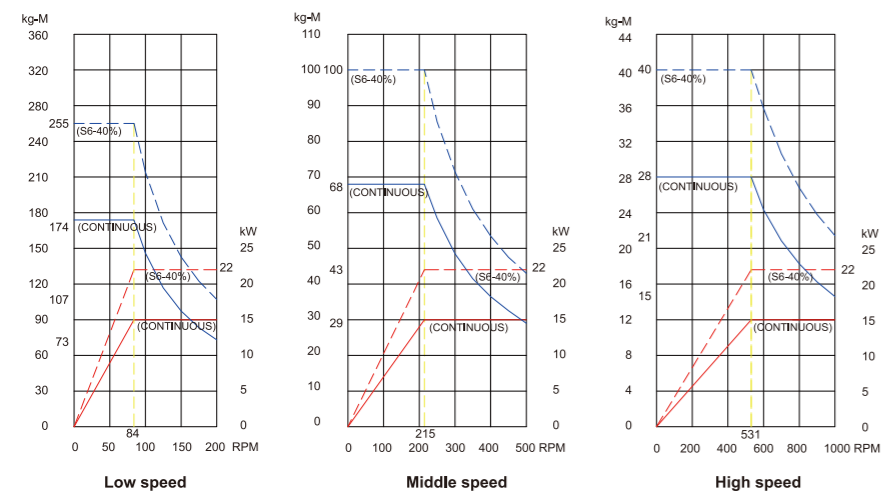

Interference diagram

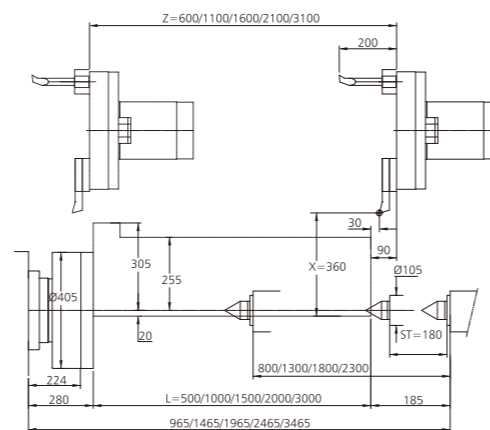

TOOL INTERFERENCE DIAGRAM

► EFL-560

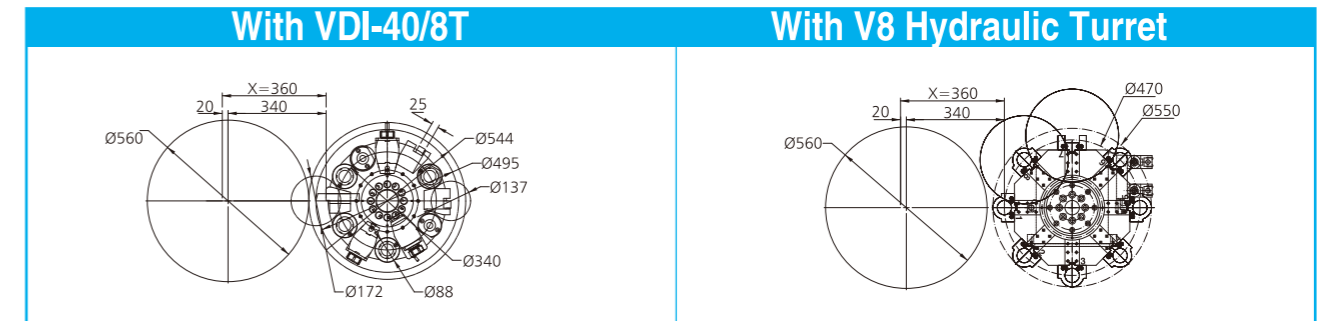

► EFL-510Y

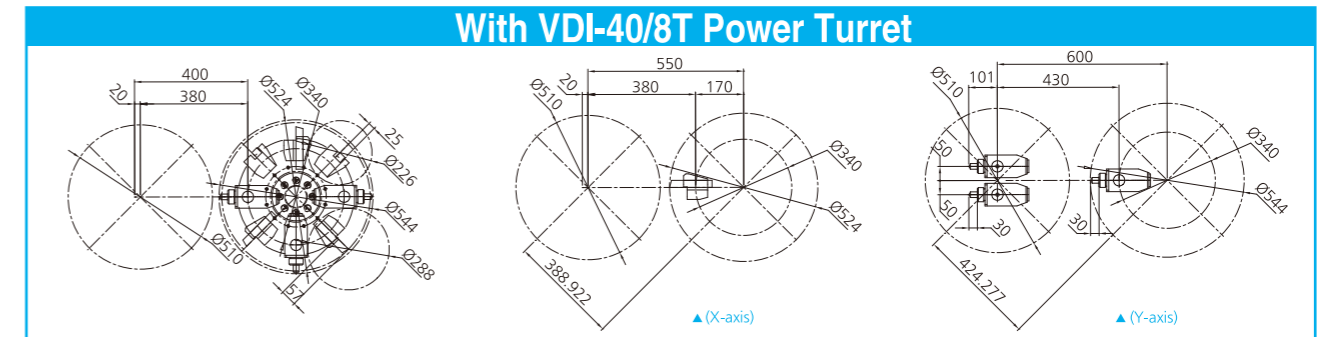

MAX. ALLOWABLE WEIGHT OF WORKING PIECE

One Chuck and Tailstock		One Chuck, One Steady Rest and Tailstock		One Chuck, Two Steady Rests and Tailstock	
1		2		3	
SPINDLE BORE:	MAX. LOADING	SPINDLE BORE:	MAX. LOADING	SPINDLE BORE:	MAX. LOADING
83 mm	1200 KGS	83 mm	2200 KGS	83 mm	3500 KGS
105 mm	1200 KGS	105 mm	2200 KGS	105 mm	3500 KGS
130 mm	1500 KGS	130 mm	2500 KGS	130 mm	4000 KGS
160 mm	2300 KGS	160 mm	3300 KGS	160 mm	4500 KGS
Only One Chuck		Once Chuck and One Steady Rest		One Chuck and Two Steady Rests	
4		5		6	
83 mm	400 KGS	83 mm	1200 KGS	83 mm	2500 KGS
105 mm	400 KGS	105 mm	1200 KGS	105 mm	2500 KGS
130 mm	500 KGS	130 mm	1500 KGS	130 mm	2600 KGS
160 mm	500 KGS	160 mm	2300 KGS	160 mm	3500 KGS

Remarks:

1. Work piece must be placed on the chuck evenly.
2. The figure may be different due to different size and clamping force of the chuck.

MACHINE DIMENSIONS

EFL-510, 560 DIMENSION DRAWING

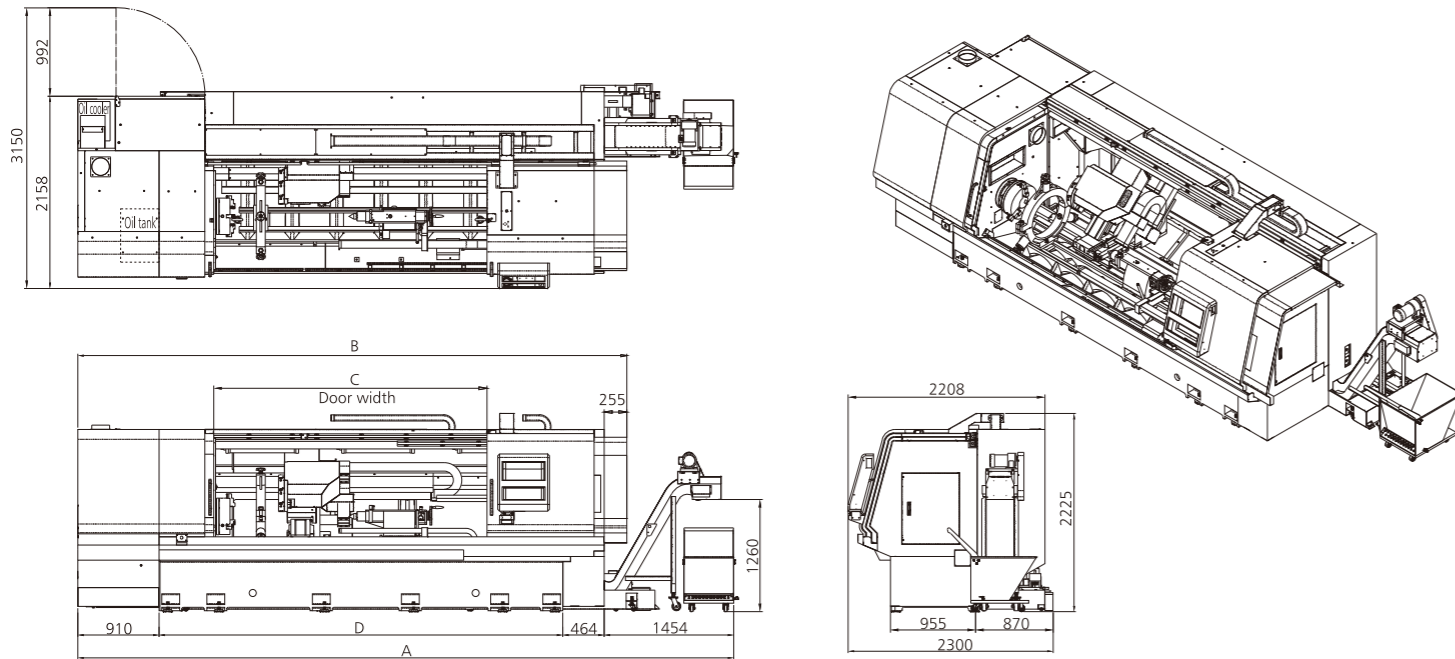

SIZE	MODEL	EFL-510/560 x 1100	EFL-510/560 x 1600	EFL-510/560 x 2100	EFL-510/560 x 2600	EFL-510/560 x 3100
A	mm	5360	5860	6360	6860	7360
B	mm	4161	4661	5161	5661	6161
C	mm	1100	1600	2100	2600	3100
D	mm	2532	3032	3532	4032	4532
Occupied floor	mm	5360 x 3150 x 2225	5860 x 3150 x 2225	6360 x 3150 x 2225	6860 x 3150 x 2225	7360 x 3150 x 2225
Net weight	kgs	7400	7800	8400	8800	9400

STANDARD ACCESSORIES

1. CNC controller
2. Automatic gear shift
3. Lubrication system
4. Spindle cooler
5. Coolant system
6. Chip enclosure
7. Manual 2-step tailstock
8. Remote MPG
9. Pilot lamp
10. Work lamp
11. Tool kit with box
12. VDI40/V8 live tooling turret for EFL-510Y

OPTIONAL ACCESSORIES

1. 3-jaw chuck
2. 4-jaw chuck
3. 3-jaw hydraulic chuck with rotation cylinder
4. Hydraulic cylinder
5. Spindle rear supporting chuck
6. V8 hydraulic turret (EFL-560)
7. VDI40 live tooling turret (EFL-560)
8. Hydraulic tailstock
9. Follow Rest
10. Bearing type steady rest
11. Hydraulic steady rest
12. CE/CSA-compliance electric and wiring system
13. M30 auto power off
14. Transformer
15. High pressure coolant gun
16. Rear chip flushing system
17. Chip conveyor

SPECIFICATIONS:

Description / Model	UNIT	EFL-560	EFL-510Y			
WORKING CAPACITY						
Swing over bed	mm	Ø710	Ø710			
Swing over carriage	mm	Ø560	Ø510			
Distance between centers	mm	1100 / 1600 / 2100 / 2600 / 3100				
Max. turning length	mm	1000 / 1500 / 2000 / 2500 / 3000				
Spindle bore max. turning bar (with hydraulic chuck)	mm	Ø70 / Ø90 / Ø110 / Ø117 / Ø142				
HEADSTOCK						
Spindle bore	mm	Ø83 / Ø105 / Ø130 / Ø160				
Max. spindle speed (3-step)	rpm	40-2000 / 40-1500 / 30-1000				
Spindle nose		A2-8 / A2-11				
Center height of spindle	mm	360				
Spindle dividing head of C axis	deg	-	0.001			
SADDLE						
X axis travel	mm	360	410			
Z axis travel	mm	1100 / 1600 / 2100 / 2600 / 3100				
Y axis travel (45°)	mm	-	±50			
AXIS FEED						
X, Z axis rapid feed	mm/min	X:10000 / Z:20000				
Y axis rapid feed	mm/min	-	10000			
X,Z axis rapid feed	mm/min	0-5000				
Y axis rapid feed	mm/min	-	0-5000			
BALLSCREW						
X, Z axis (Dia. x pitch)	mm	X: Ø32 x P=5 Z: Ø50 x P=12 (≤1600model) / Ø50 x P=16 (≥2100model)				
Y axis	mm	-	Y: Ø32 x P5			
TOOL HOLDER						
Hydraulic turret		V8 / V12 (Opt.)				
Live turret		V8 (VDI 40) (Opt.)				
TAILSTOCK						
Quill dia.	mm	Ø105				
Quill I.D. taper		MT#5				
Quill travel	mm	200				
MOTOR						
Main spindle motor	kW	15 / 18.5				
X,Z axis servo motor	kW	X: 3 Z: 4				
Y axis servo motor	kW	-	Y: 3			
Milling axis motor	kW	-	3.7 / 5.5			
Coolant pump	bar	2 (50HZ) / 3 (60HZ)				
Coolant flush motor	bar	3.5 (50HZ) / 5 (60HZ)				
Hydraulic tank horsepower	HP	2				
Coolant pump for spindle	HP	1/2				
TOTHER						
Controller		FANUC / FAGOR / SIEMENS				
Power requirement	KVA	30		30		
Machine net weight	kg	7400	7800	8400	8800	9400
(Distance between centers)	mm	(1100)	(1600)	(2100)	(2600)	(3100)